

Robots on the Rise

Fueling the factory
of the future

The logo features a green stylized 'C' icon to the left of the text 'Castrol' in red and 'Robotic Solutions' in dark grey below it.

Castrol
Robotic Solutions

CONTENTS

Industrial robots on the rise:
Fueling the factory of the future

FOREWORD
PAGE 03 /

**ABOUT THE
RESEARCH**
PAGE 03 /

**EXECUTIVE
SUMMARY**
PAGE 04 /

**PART 01
THE ROBOTICS
REVOLUTION**
PAGE 05 /

The size of the market
PAGE 06 /

Harnessing the power of robotics
PAGE 07 /

The COVID-19 catalyst
PAGE 08 /

**PART 02
REACHING
OPTIMAL
ROBOTS**
PAGE 09 /

Challenge 1: Reliability
PAGE 10 /

Focus on: US and EU
PAGE 12 /

Challenge 2: Efficiency
PAGE 11 /

Focus on: China
PAGE 12 /

Challenge 3: Convenience
PAGE 11 /

Focus on: Japan
PAGE 13 /

**PART 03
THE SOLUTION**
PAGE 14 /

Product development and innovation
PAGE 15 /

Education – Masters of robots needs more awareness
PAGE 16 /

Digitization – Improving robot maintenance for the future
PAGE 16 /

**CASTROL
INDUSTRIAL**
PAGE 17 /

**ABOUT
CASTROL**
PAGE 17 /

**CREDITS &
DISCLAIMER**
PAGE 18 /

FOREWORD

Industrial robots are on the rise, but are manufacturers equipped to keep them running at optimum efficiency?

The Fourth Industrial Revolution (Industry 4.0) has seen traditional manufacturing processes being revolutionized by emerging technologies, including robotics. Manufacturers have realized that, when it comes to quality and efficiency, the best way to compete is to automate their factories with robots - whether they are programmed to carry out autonomous tasks or support manual processes. And for those who were hesitant to embrace robotics, the COVID-19 pandemic may have been a catalyst for change. But the benefits of factory automation don't come without challenges; implementing robotics into the manufacturing process is only the beginning. Manufacturers must be properly equipped to get the most from their robotic workforce, and this involves choosing the right lubricant – a single minute of interruption can cost an automotive manufacturer roughly US\$ 22,000¹.

We spoke to a panel of experienced robot, automotive, and electronics OEMs about the challenges they face when it comes to robot maintenance and the part that the right lubricant can play in overcoming these. We also discussed the wider knowledge sharing that is required to increase manufacturers' confidence in choosing their own lubricants.

“The robotics revolution has arrived and armed with the right tools - and knowledge - industrial manufacturers can harness the true power of this technology.”

↑ Ramchander A.S., Chief Marketing Officer, Castrol

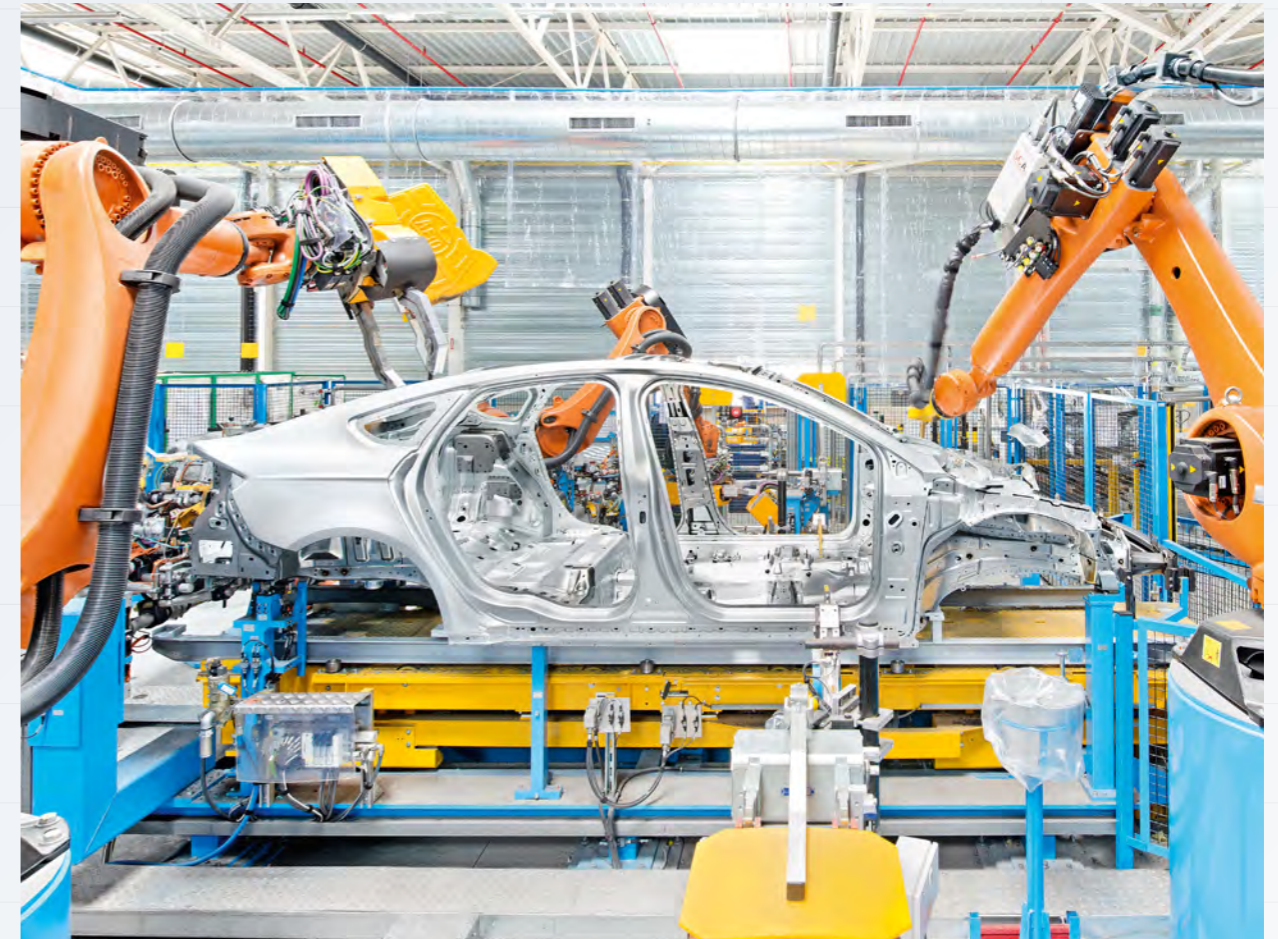

ABOUT THE RESEARCH

This report is based on qualitative research carried out by iResearch on behalf of Castrol in 2020, examining the challenges of servicing and maintaining robots used in industrial manufacturing.

Qualitative interviews were conducted among more than 25 Robot OEMs and Aftermarket OEMs from the automotive and electronics sectors, across the following regions: the US & Europe; China; and Japan.



EXECUTIVE SUMMARY

Robots on the Rise examines the opportunities presented by the use of robotics in industrial manufacturing and the barriers that stand in the way of a successful automation journey.

There is high demand from the aftermarket sector (automotive OEMs and electronics OEMs) for robotics - and this is only set to increase. However end-users face a number of challenges when it comes to the maintenance of their robots, specifically in relation to lubricants, and these need to be overcome through product development, education and training, and the advancement of technology in lubrication maintenance.

Key findings:

01 /

Demand for high-quality lubricants is set to increase as robot use is on the rise; **one leading automotive OEM reported that over 60% of their lubricant budget goes on robotics.**

02 /

Customers face three key challenges when choosing a lubricant:

Reliability

Selecting a lubricant that ensures zero downtime, reduces leakage, and performs with high precision under extreme conditions.



of robot and aftermarket OEMs identified leakage resistance as a key lubricant requirement.

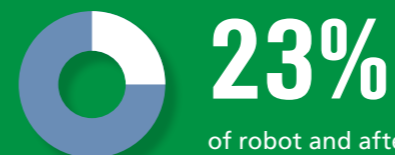

of robot and aftermarket OEMs stated the importance of finding a lubricant that operates in extreme temperatures.

Efficiency

Selecting a lubricant that conserves energy and reduces wastage.

Convenience

selecting a lubricant that is long-lasting and brand agnostic, making the maintenance process as straightforward as possible.

03 /

If customers are not happy with their lubricant, there are barriers preventing them from making the switch to an alternative product:



Lack of knowledge and technical expertise.



A general concern about the durability of lubricating oil compared to lubricating grease.

04 /

Product development and innovation are key to overcoming the challenges of robot maintenance, and customers need **education and training** on the solutions that are available.

05 /

Technology also has a key role to play, but the **current lubrication maintenance software needs to be advanced.**

PART

01 /

The size of the market
PAGE 06 /

Harnessing the power of robotics
PAGE 07 /

The COVID-19 catalyst
PAGE 08 /

THE ROBOTICS REVOLUTION

THE SIZE OF THE MARKET



The number of industrial robots operating in factories around the world today marks the highest level ever recorded.

Data from the International Federation of Robotics (IFR) reveals that global operational stocks experienced an increase of around 85% between 2015 and 2020, with the industrial robotics industry gaining its highest demand from end-users such as automotive and electronics OEMs. One of the reasons for this surge in robot use is cost, since the average selling price for a robot has fallen by more than half over the past 30 years.

Castrol's research revealed that by 2025 there could be more than **4 million** industrial robots in operation.

These findings are supported by further research in this field which shows that the size of the market is only set to increase. A report by Oxford Economics stated that the global stock of robots could reach as many as 20 million by 2030, 14 million in China alone, and BCG (Boston Consulting Group) has conservatively projected that the robotics market will reach \$87 billion by 2025.

↓
 "As the robotics market grows, so does the demand for high-quality aftercare products. One leading automotive OEM interviewed by Castrol reported that **over 60% of their lubricant budget goes on robotics.**"

Installations of Industrial Robots – World (1,000 Units)

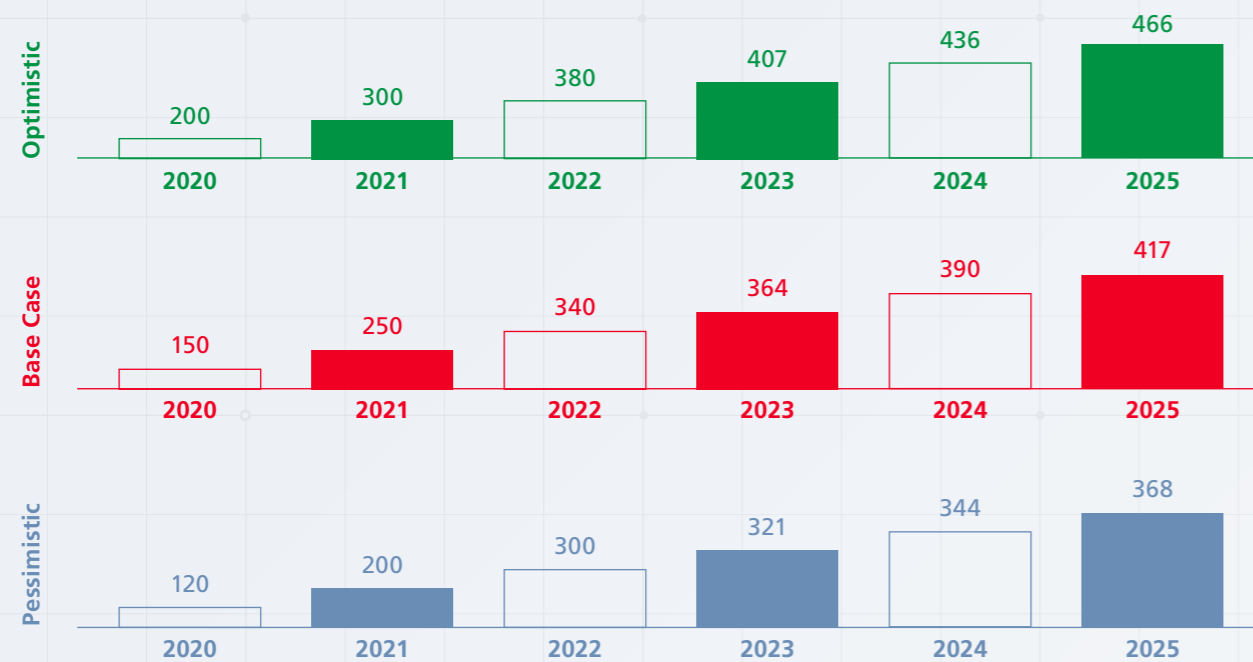

Operational Stock of Industrial Robots – World (1,000 Units)

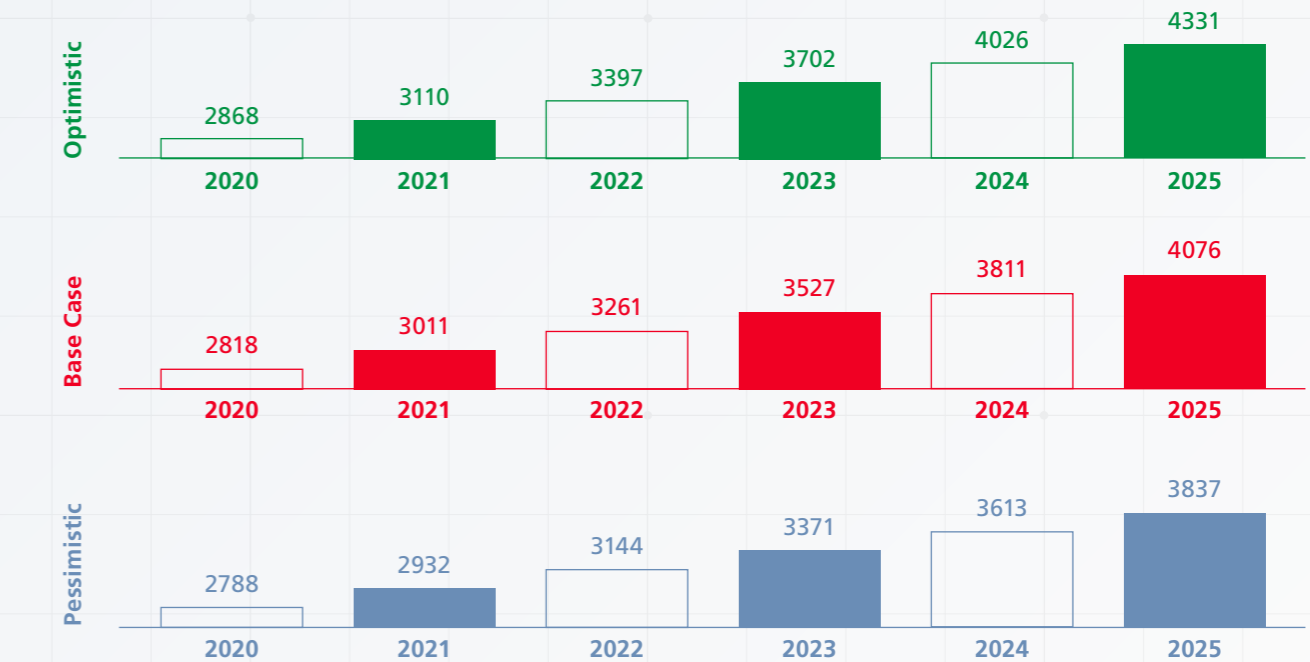

HARNESSING THE POWER OF ROBOTICS

This strong growth forecast is driven not only by the reduced cost of robotics but also by the benefits they offer. Industrial robots are now capable of performing the most dangerous, oppressive, and routine chores.

For end-users this means:

1 / **A boost in productivity and economic growth.**

2 / **A cleaner working environment with lower risk of contamination.**

3 / **Increased levels of precision.**

4 / **Improved safety for their workers.**

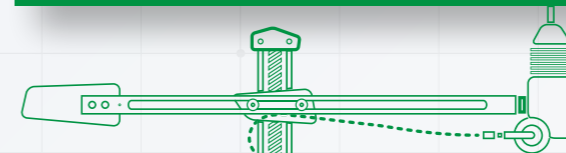

Credit: iResearch

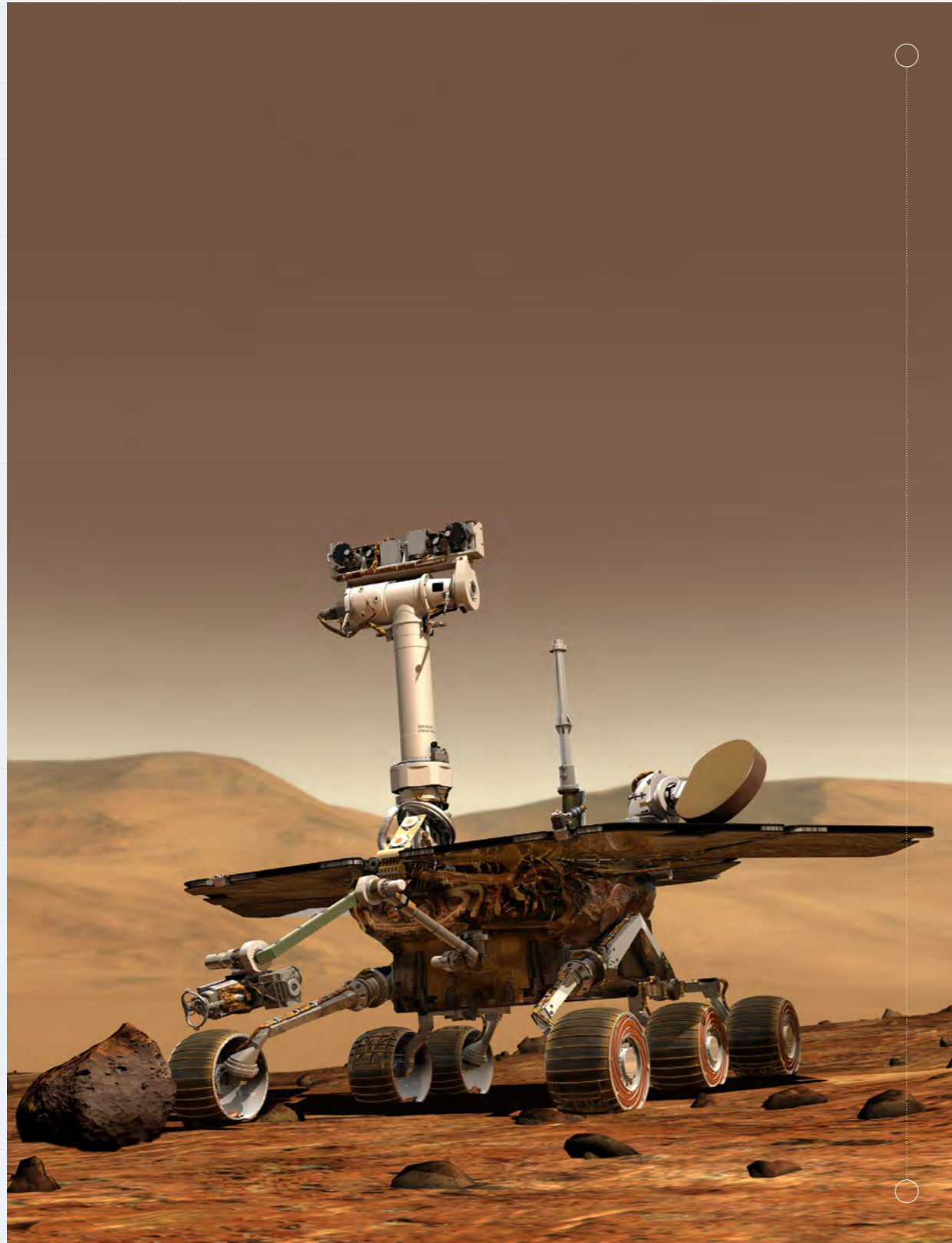



THE COVID-19 CATALYST

The industrial robotics market is not immune to disruption however, and it has been battling against COVID-19 headwinds. The global pandemic has impacted budgets, and with the global economy facing a substantial period of recovery, it is still affecting manufacturers' ability to invest.

However, with all great crises comes opportunity. The industrial manufacturing sector has had to adapt to survive the pandemic, and this change of pace in organizational transformation could see COVID-19 forcibly accelerate a paradigm shift to a "5S" future where robots and automation are the change agents.

5S Future: Where robots & automation are the change agents.

Trend

Contribution of Robot

1/ Slow recovery

The slow recovery of the economy imposes financial stress on factories.

The use of robots helps decrease labor costs and ensures increased efficiency within production.

2/ Supply resilience

COVID-19 drives key manufacturing countries to rethink the resilience of their supply chains.

Robots help lower the cost of reshoring manufacturing.

3/ Smart factory

More factories realize that we are headed towards Industry 4.0 and work to catch up with digitalization to make production more flexible.

Robots can be connected with other equipment, as one of the key components of the smart factory.

4/ Smaller batch

Murky consumption, shorter product cycles, and demand for personalized products call for smaller batch production.

Collaborative robots (cobots) enable small-batch goods to be produced more cost-effectively.

5/ Sustainable

The Green Deal launched by the EU to fund a sustainable recovery puts net-zero transition firmly on the agenda for manufacturers.

The increased level of accuracy provided by robots helps to 'green' manufacturing processes by minimizing error and, therefore, reducing waste.

PART

02 /

REACHING OPTIMAL ROBOTS

Challenge 1: Reliability
PAGE 10 /

Challenge 2: Efficiency
PAGE 11 /

Challenge 3: Convenience
PAGE 11 /

Focus on: US and EU
PAGE 12 /

Focus on: China
PAGE 12 /

Focus on: Japan
PAGE 13 /

KEY CHALLENGES TO OVERCOME

With this growing army of robots comes a new challenge for automotive and electronics OEMs: how do they keep them working and ensure they are operating as effectively and efficiently as possible? Castrol's research identified that aftermarket clients need help overcoming the following challenges and concerns when it comes to selecting the right lubricant.

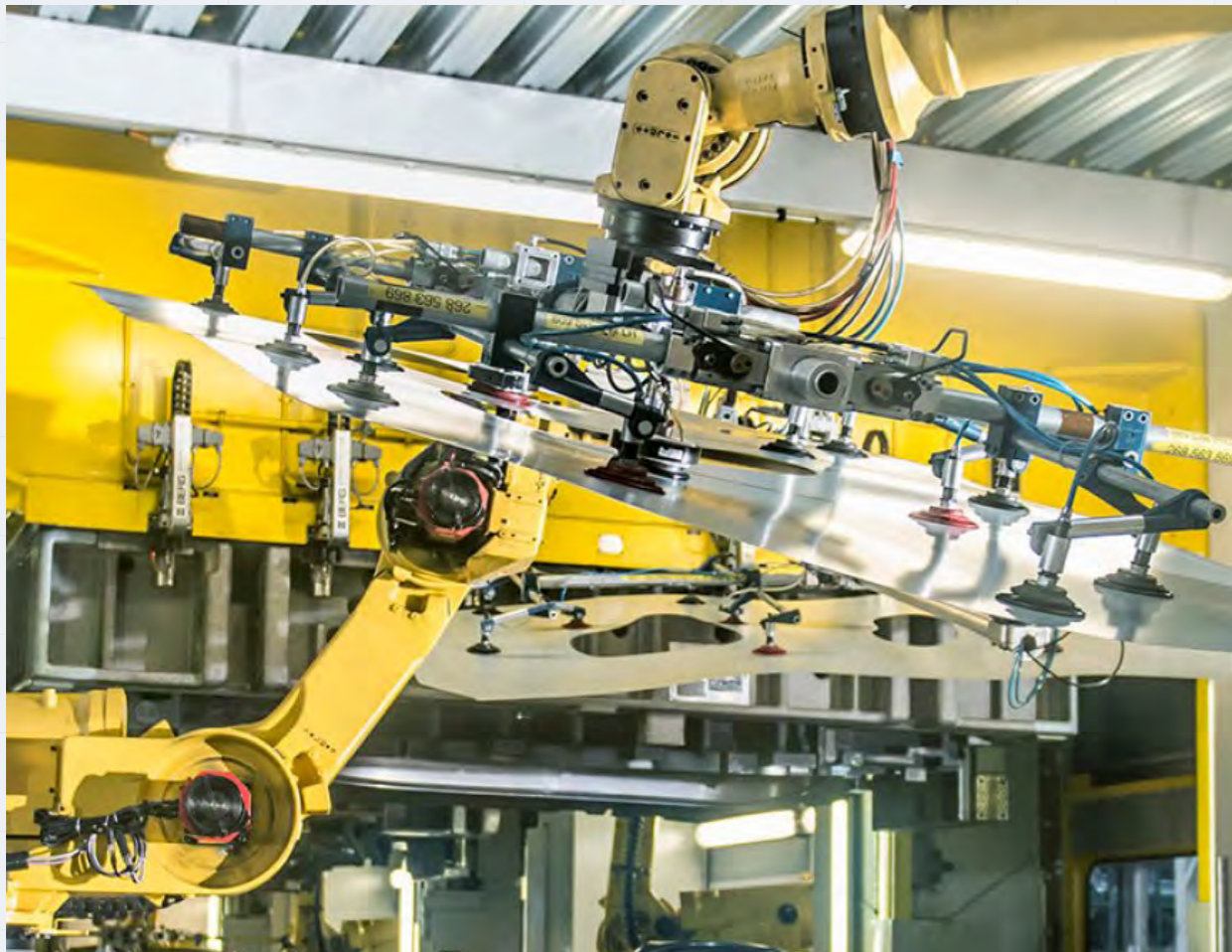

Challenge 1/ Reliability

Firstly, OEMs need a lubricant that is reliable. The expert panel indicated that the number one concern for OEMs is protecting against leakage. This is vital for avoiding contamination in cleanroom production. It is also a prevalent issue in the automotive sector due to the increased need for lubrication, and therefore the increased risk of leakage, in articulated robots; if product leaks onto the body of a car, the wastage, and subsequent expense, can be significant.

“Robots of different brands do not vary in function, but they do in reliability. Reliability is reflected by a set of metrics, such as failure rate, life span, and working cycle.”

(Electronics OEM)

Lubricants must ensure zero downtime: a single minute of interruption can cost an automotive manufacturer roughly US\$ 22,000.¹ They must also be able to withstand temperature extremes. Low-temperature performance is particularly important because if the lubricant congeals, it can trigger over-torque or collision alarms.

¹Based on the industry research with 101 manufacturing executives in the automotive industry conducted by Nielsen Research, and commissioned by Advanced Technology Services, Inc. (ATS). While one minute of stopped production, or downtime, costs an average of \$22,000, some survey respondents cite the figure to be as high as \$50,000 per minute.



of the experts interviewed identified leakage resistance as a key consideration.



identified the importance of finding a lubricant that operates in extreme temperatures.

“We use different lubricants in northern and southern factories. We’re concerned about the temperature differences inside and outside the plant.”

(Electronics OEM)

Finally, anti-wear is important in ensuring a high-quality end product, especially in the production of intricate electronic components where precision is particularly vital. Wear on a gearbox could lead to incorrect positioning, impacting the quality of the product.

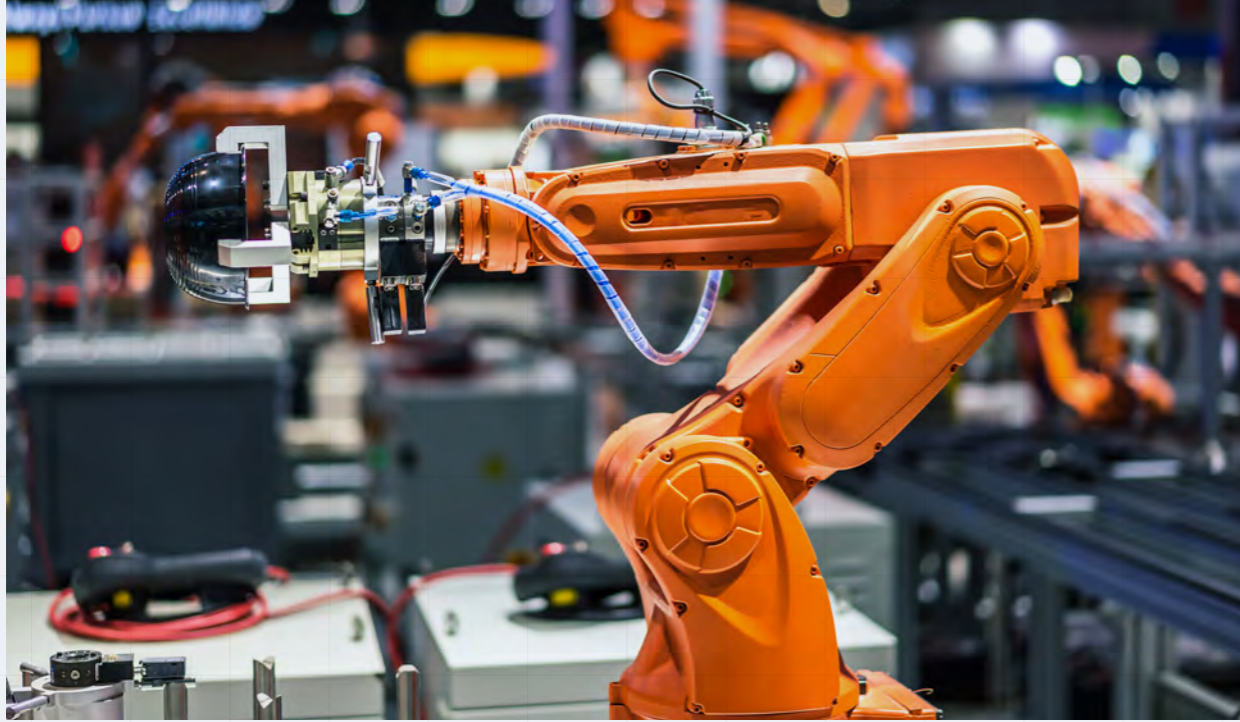

Challenge 3 / Convenience

Finally, lubricants must be more convenient. Automotive and electronics OEMs need lubricants that are optimized to make the maintenance process easier; they should be simple to use and long-lasting. Electronics robots, for example, are expected to run for two years without any maintenance. It is also important that lubricants are brand agnostic so that they can be used across different robots and the impact of using the wrong lubricant is minimized.

“Robotics lubricant should bring more value of convenience in the future.”

(Robot OEM)

Different markets have their own set of challenges for automotive OEMs and electronics OEMs dealing with robotics.



Credit: NASA

Challenge 2 / Efficiency

The second challenge that OEMs are looking to overcome is that lubricants must be efficient, increasing production efficiency, production yield, and maintenance efficiency.

Production time and cost are no longer the only considerations for OEMs, with government and consumer demands putting environmental concerns front-of-mind. A recent survey by Castrol revealed that 92% of manufacturing professionals believe sustainability requirements will be important in the process of choosing a lubricant, and that energy saving is the top priority.²

In order to increase energy efficiency, lubricants must work to reduce friction and, consequently, the mechanical power required. This leads to robots being able to operate at lower temperatures, which reduces their energy usage and environmental impact. It is also important that lubricants increase the accuracy of robotics in order to minimize waste.

Many of the OEMs consulted by Castrol expressed that precision checking and lubrication are particularly time-consuming when it comes to robot maintenance.

The most time and effort consuming part of maintenance in daily inspection.

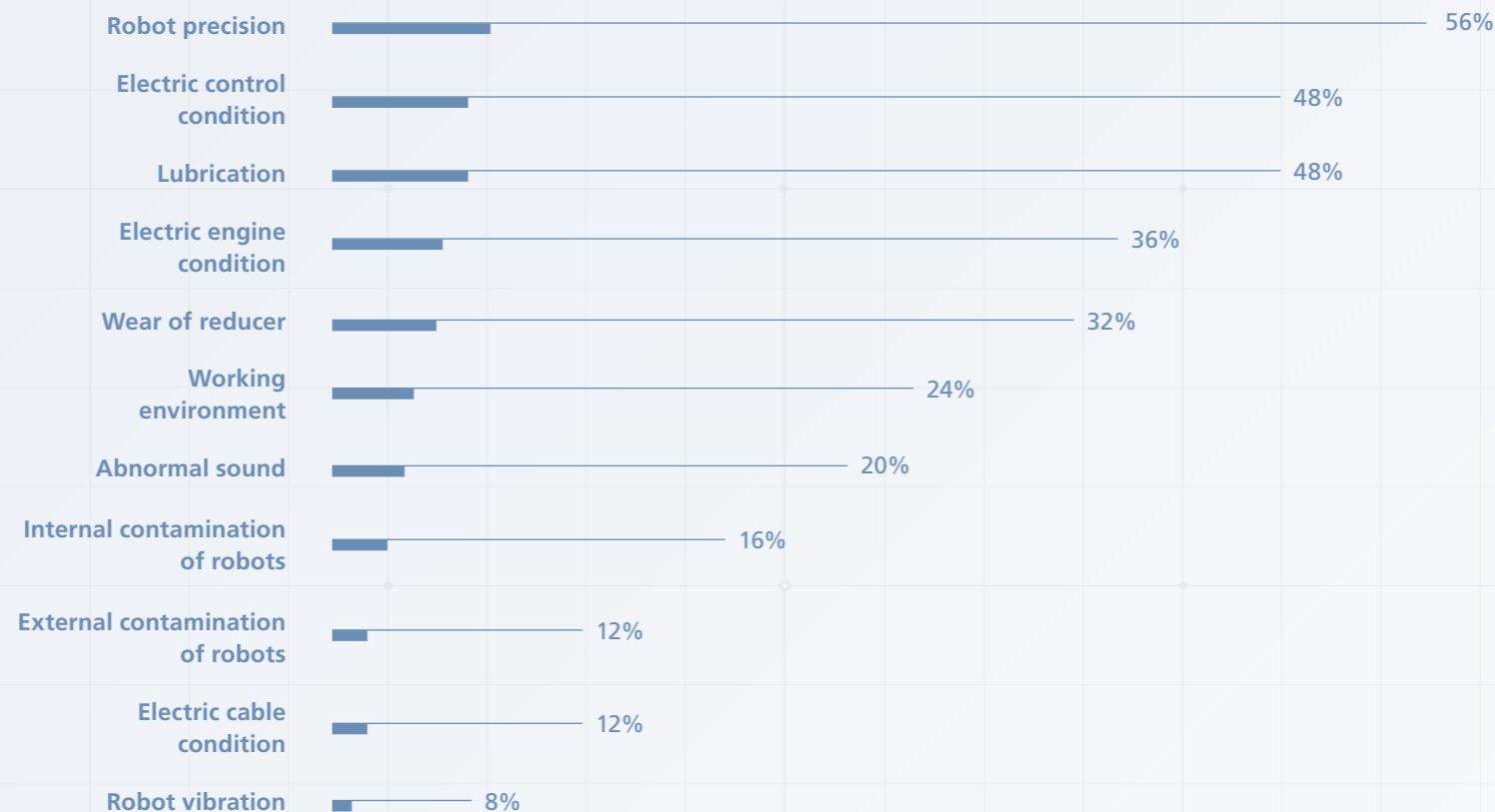

Credit: iResearch



Focus on: US & EUROPE



In the US and Europe, reliability and durability are the top considerations for OEMs when choosing a lubricant. Lubricants must minimize downtime and help to achieve a long service interval, with manufacturers looking for their robots to reach 20,000 working hours before a lubricant change is required. Lubricants must also perform in a wide range of temperatures and minimize the risk of leakage.

“The lubricant should last longer, and the process of lubricating should be easier.”

(Robot OEM, Belgium)

“I can tell by the smell of it. When it’s going bad, I can tell by the way it looks. But that’s just because I’ve been using it for so many years.”

(Automotive OEM, USA)

The maintenance of robots is currently highly dependent on experience, which requires a well-trained and senior in-house maintenance team. Lubrication maintenance software could offer a solution, but this technology is still in its infancy.

Focus on: CHINA



China, in particular, will see automation surge, partly in response to the government’s Made in China 2025 plan. Introduced in 2015, the plan aims to transform the country into the world’s top manufacturing powerhouse by improving product quality through greater automation. To achieve this goal, the plan calls for the local production of robots to increase from about 150,000 in 2020 to 400,000 by 2030.

Key insights from the expert panel found revealed that COVID-19 has accelerated the need for factories in China to be more aware of maintenance, with the top three objectives being:

- 1/ Increasing production efficiency
- 2/ Increasing product yield
- 3/ Increasing maintenance education

In China, end-users face limited choice when it comes to lubricants, and are therefore less able to take advantage of a broader range of products that could help them overcome critical challenges. Key requirements on their lubricant wish-list are a product that extends the life of the robot, operates in a wide temperature range, ensures higher productivity, and eliminates leakage.

Castrol’s research found that clients in China tend to agree that a lubricating grease is better for a reducer than a lubricating oil. When asked why clients in China felt grease was the best choice, many responses seemed to come from perceptions rather than them being equipped with the right information to have a deeper understanding. Therefore, education will be fundamental in giving the aftermarket more autonomy when choosing the lubricant that is best suited to their needs.

“The most important value would be the prevention of major downtime. Productivity is the top-of-mind concern for the leadership team.”

(Automotive OEM, China)

“Our factories demand cleanness: lubricant leakage is not acceptable. Besides, lubricant oil is more likely to be used in higher temperatures, but high temperature won’t take place in our operational environment.”

(Electronics OEM, China)

Focus on: JAPAN



In Japan, the top requirements for a lubricant are OEM approval, durability, and protection against wear.

“[Clients complained] winter in northern Japan could be tough for the robot. The grease becomes so hard that the system detects it as outside material and sends out a red flag.”

(Robot OEM, Japan)

“The biggest concern is axial deviation, which is greatly affected by lubrication. The wear of gear or other parts of the robot could cause axial deviation of the upper arm.”

(Automotive OEM, Japan)

Castrol research looked into the new trends within the rotate vector (RV) reducer and strain wave (harmonic) reducer industries and identified the key technology trend to be compactness. Innovation will be required to produce lubricants that guarantee good performance with lower filling volume.

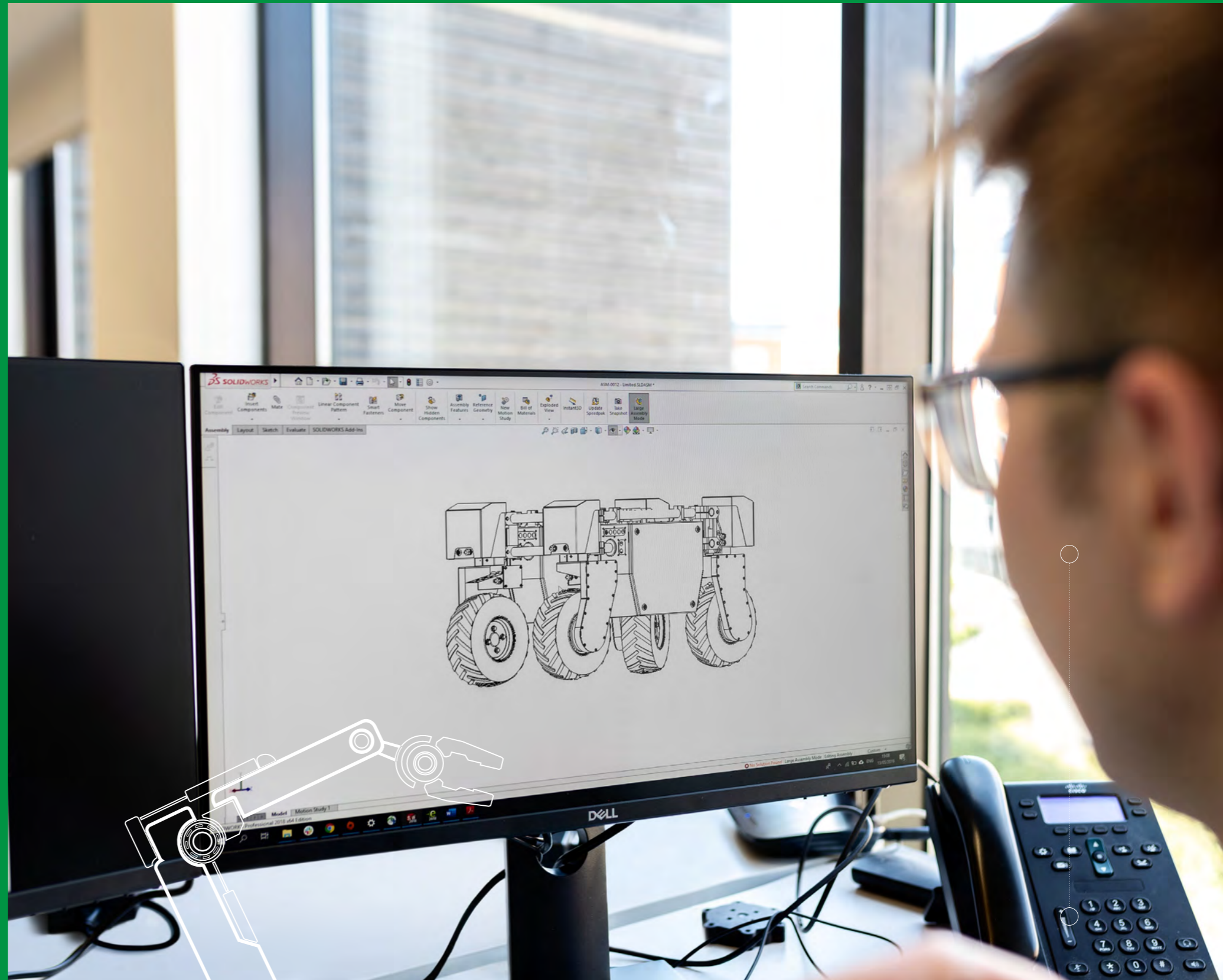

PART

03 /

THE SOLUTION

Product development and innovation

PAGE 15 /

Education –

Masters of robots needs more awareness

PAGE 16 /

Digitization –

Improving robot maintenance for the future

PAGE 16 /

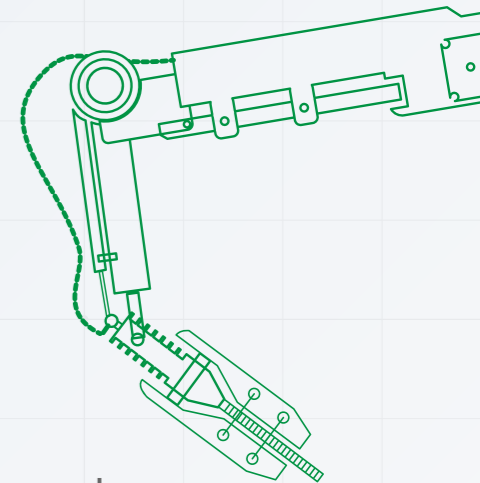

PRODUCT DEVELOPMENT AND INNOVATION

Continuous research and development is crucial to supply automotive and electronics OEMs with a lubricant that is reliable, efficient, and convenient. And, with Industry 4.0 driving major advancements in robotics, innovation is critical to ensure that solutions are aligned with evolving robot designs.

In order to reach the service interval goal of 20,000 hours, the development of purely fully-synthetic formulas will be needed to provide improved oxidation stability. Advanced lubricants also have a significant role to play in helping to reduce carbon emissions during the manufacturing process. The use of plastic deformation (PD) additives can minimize friction within robots, therefore lowering the temperature and the mechanical power required - and saving energy.

However, the use of higher additive levels to protect against wear can result in residue which prevents the lubrication of sealing systems - leading to leakage. Therefore, the next generation of lubricants must contain optimized additive levels, extending robot lifetime while eliminating leakage - and therefore, bringing energy efficiency back to a good level.

As customers focus on their carbon footprint, they are also looking for materials with lower environmental impact, such as bio-sourced raw materials and re-refined base oils. This will be a key area for innovation moving forward, as confirmed by Castrol's sustainability survey which found that 96% of manufacturing professionals believe that re-refined industrial lubricant would be of value for their company.

Stefan Mooren,
Castrol Technical
Engineering Manager ↴

“Collaboration will be crucial in developing the next generation of lubricants. Joint research and development between lubrication suppliers and end-users will be key to making sure products are meeting the evolving needs of the market - it's an ongoing project.”

EMPOWERING THE MASTERS OF ROBOTS

Ultimately, the most important solution to these challenges is developing the right products to support and enable industrial customers in the transition to automation.

In a world that is increasingly dependent on robotics, aftermarket customers are also looking for suppliers that can add value. For end-users to get the most out of their robots, they need more information - in the form of training and education. But technology needs to play its part too and make maintenance easier, rather than being another issue for technicians to grapple with.

EDUCATION

MASTERS OF ROBOTS NEED MORE AWARENESS

Lubrication is an integral part of robotics aftercare, and most end-users currently lack the level of knowledge required when it comes to best maintenance practices.

The main focus areas for education are:

1/ Oil vs. grease

the capabilities of oil, such as durability and reliability under extreme temperature conditions.

2/ Usage

how maintenance teams can ensure time efficiency.

3/ Cost

why the cheapest option isn't necessarily the best one because of the trade-off on performance.

It is important that lubricant suppliers provide a good service behind their product. End-users, particularly automotive OEMs, require an open line of communication with suppliers to allow them to ask questions about lubricant qualities and applications as they arise.



Daryl Luke, Castrol
Global Product Manager ↘

"When facing maintenance challenges, many OEMs focus on the design elements of their robots. It's important to increase aftermarket customers' awareness of the importance of lubricants in helping to solve these challenges."

DIGITIZATION

IMPROVING ROBOT MAINTENANCE FOR THE FUTURE

Technology has begun to play a role in the maintenance of robots, but there is a long way to go for it to make end-users' lives easier.

Customers currently base maintenance decisions on experience over data, demonstrating their lack of confidence and reliance on the software that is currently available. The value of data analytics in the maintenance of robots - specifically condition monitoring and smart lubrication - must be weighed against the cost involved in setting-up and running these systems. However, access to this information would enable engineers to plan maintenance and troubleshoot issues, maximizing equipment uptime.

The area in which this technology holds the most potential is in specific lubricant performance improvement projects. Used oil analysis can assist customers in widening the service intervals of their robots by carrying out oil checks on their hardest working robots. These results can help to determine whether an alternative lubricant would help to extend a robot's lifetime, which would have great benefits for manufacturing efficiency.

"The value of the system would be cutting costs by reducing downtime. The biggest value for instance in automotive is to have the information for certain parts of the robot. If you have the information on the temperature of the central processing unit (CPU) exceeding a certain number, the maintenance team can do the fixing at any time without obstructing the production badly."

Robot OEM

Stefan Mooren,
Castrol Technical
Engineering Manager ↘

"The most valuable use of technology can be seen in improving maintenance intervals. If automotive OEMs can use data to analyze the lubricant performance of their hardest working robots and get them to the target of 20,000 working hours between maintenance checks, they can be confident that they can achieve this in the 500 other robots on their factory floor."

CASTROL INDUSTRIAL

Castrol has been collaborating with industrial businesses since 1899. Our heritage of high-tech lubricants and proof of no leakage, faster starting times and decreased power usage has impacted major industries across the globe - which is why our products were also chosen by NASA for robotics equipment on Mars.

We are constantly working to innovate, developing lubricants to help decrease the downtime of industrial robots and positively impact the quality, cost, and efficiency of manufacturing processes.

Castrol is also ideally positioned to support automotive and electronics OEMs on their aftercare journey. To learn more about our advanced robotics solutions [click here](#).



Castrol
Robotic Solutions

ABOUT **Castrol**

Castrol provides the oils, fluids and lubricants the world needs, for every driver, every rider and every industry. It's more than just oil. It's liquid engineering.

The world of transport is going electric and e-fluids have a vital role to play. EVs play a key part in the mobility revolution and the pathway to decarbonising transport. Castrol's e-Fluid expertise extends across land, sea and even space.

In space

Castrol e-Greases help keep NASA's \$820 million InSight Mars Lander working in the unforgiving conditions on the Red Planet.

Developments include Castrol's lowest viscosity e-transmission oil, designed for efficiency, durability and reliability. Castrol is partnering with major manufacturers to ensure its lubricants deliver what drivers want: to go further on a single charge, enable longer life of transmission and component parts, and ensure long-lasting battery health.

At sea

Castrol e-Fluids support equipment used in the transfer of power from an engine or electric motor to a propeller or thruster.

As EVs continue to evolve, Castrol's best brains are not only defining the fluids, but the way the fluids are defined: pioneering unique testing and monitoring methods, driving efficiency and economy going beyond the standard requirements of the fluids, taking consumer insights and engineering technical solutions; advancing technologies that will lead to breakthroughs for the transport of tomorrow.

On land

Castrol has developed a range of e-fluids to meet the needs of vehicle manufacturers. From transmission e-fluids, which are inside many EVs already on the road, to e-Greases and e-Coolants, these fluids enable electric vehicles to run smoothly, efficiently and stay cool.

To find out more about Castrol please visit www.castrol.com

CREDITS

Robots on the Rise: Fueling the factory of the future is based on qualitative research commissioned by Castrol, conducted by iResearch, and written and produced by Man Bites Dog. Image credits attributed throughout the report.

DISCLAIMER

The information in the whitepaper is provided for guidance and informational purposes only. The information contained herein has been compiled from sources deemed reliable and it is accurate to the best of our knowledge and belief.

However, Castrol cannot guarantee its accuracy, completeness, and validity and cannot be held liable for any errors or omissions, as the results change depending on the working condition/environment. The content and information within the whitepaper are not intended to provide investment, laboratory or manufacturing process advice. Changes are periodically made to this information and may be made at any time. All information contained herein should be independently verified and confirmed.

